

CAUTION - READ MANUAL & ALL NOTES BEFORE INSTALLING OR OPERATING CONTROL. SEE NOTE 1. NO CIRCUIT CALIBRATION OR ADJUSTMENT EVER REQUIRED.

HAZARDOUS VOLTAGE FOR SERVICE ON THIS CONTROL. DANGER NOTICE. FOR SERVICE ON THIS CONTROL. Contact Your Machine Dealer Or ENTRON CONTROLS LLC. DIRECTLY: (800) 416-0190. 601 HIGH TECH COURT, GREER, SC 29605, FAX# (864) 616-9195.

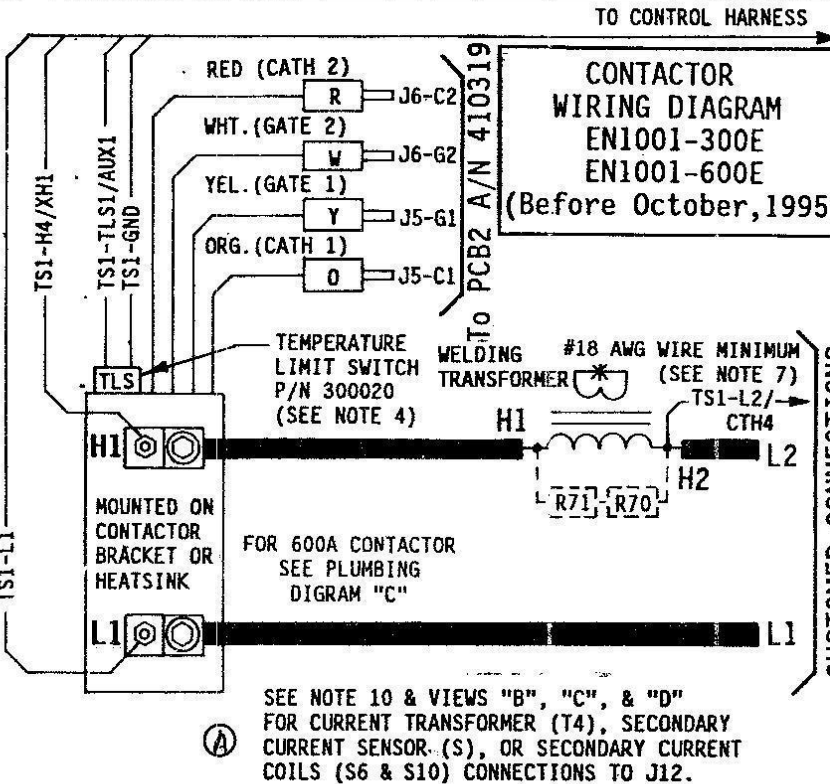

NOTE: PRIOR TO 1-15-93, OPTIONAL 575V VALVE TRANSFORMER (T3) WAS P/N 311007. WIRE FROM T3-1/L2/CTH4 WAS CONNECTED TO T3-H3. T3-H3 SCREW POSITION WAS IN SAME LOCATION AS T3-H2.

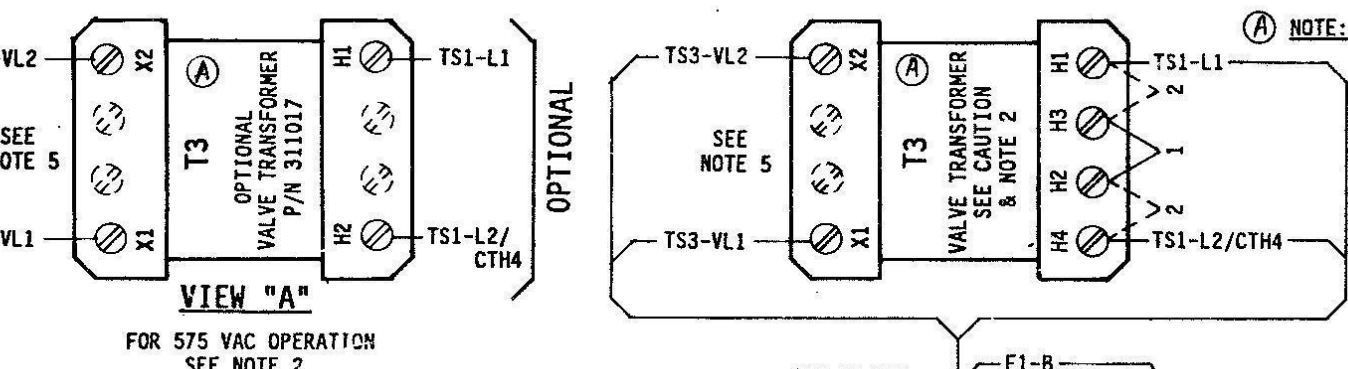

NOTE: SCREW TERMINAL POSITIONS SHOWN IN DASHED LINES ARE PART OF T3 P/N 311002 AFTER 6-16-97. THE NEW SCREWS PERFORM NO ELECTRICAL FUNCTION.

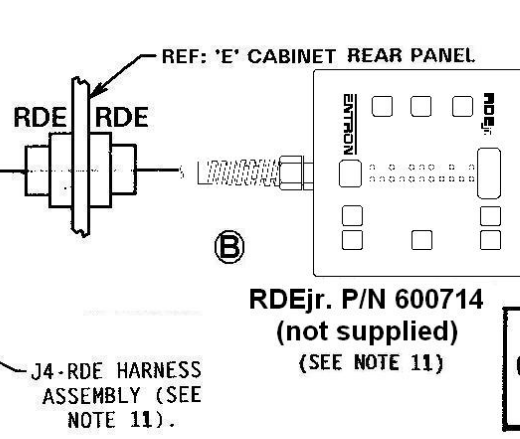

CAUTION Control Shipped Wired for 460 VAC Operation unless otherwise specified - See Note 2.

CURRENT SENSING COIL/SENSOR APPLICATION CHART. Table with columns for COIL/SENSOR MODEL NUMBER, CURRENT TRANSFORMER OR SECONDARY CURRENT SENSOR PART NUMBER, and CONTACTOR SIZE (300A, 600A, 1200A, 1800A, 2200A).

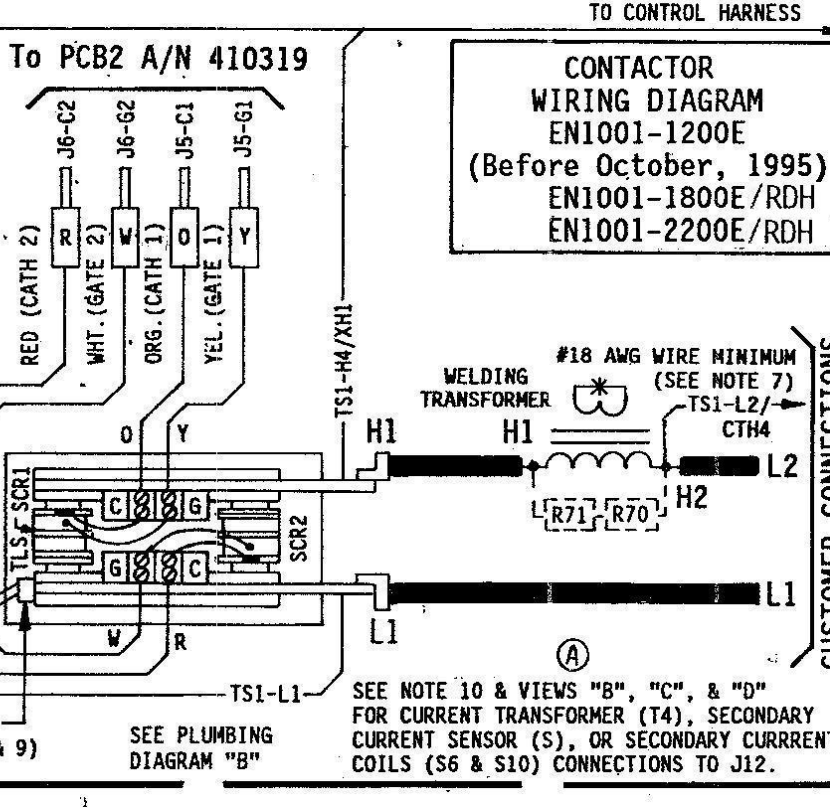
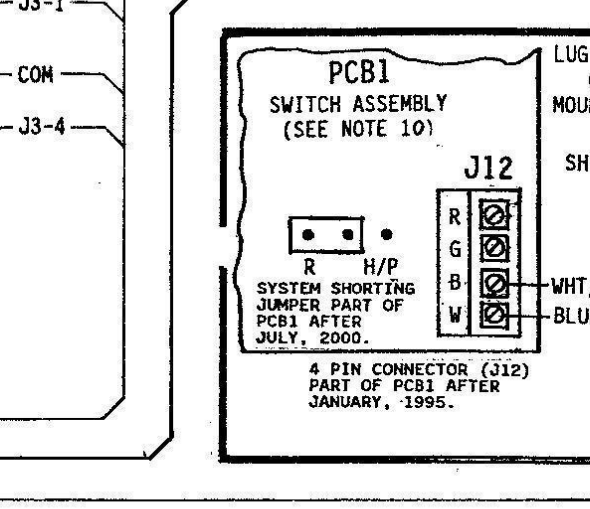
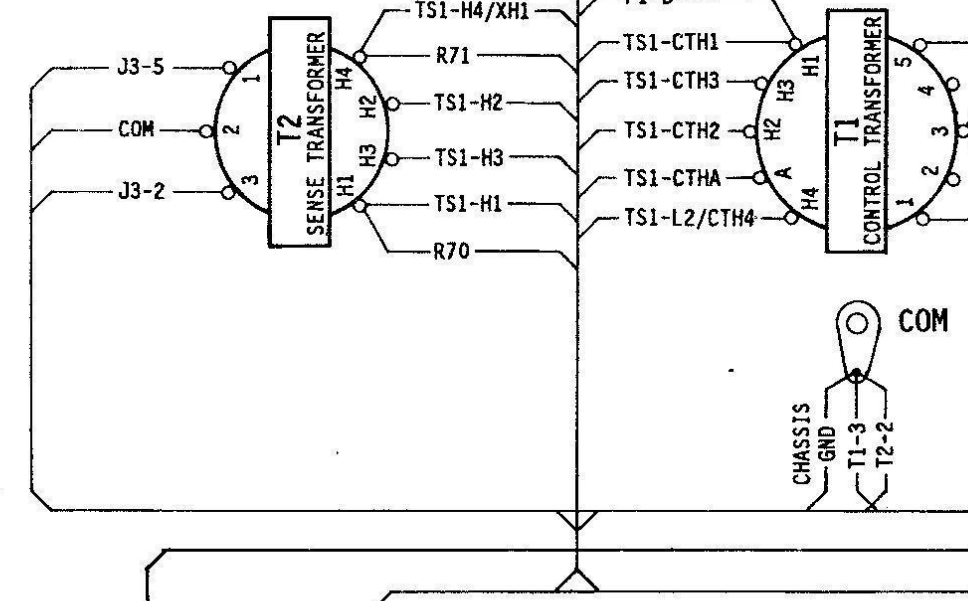

X - ONE CURRENT TRANSFORMER ASSEMBLY, ONE SECONDARY CURRENT SENSOR ASSEMBLY, OR ONE SECONDARY CURRENT COIL.

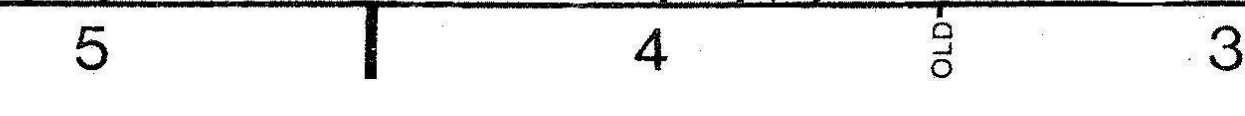
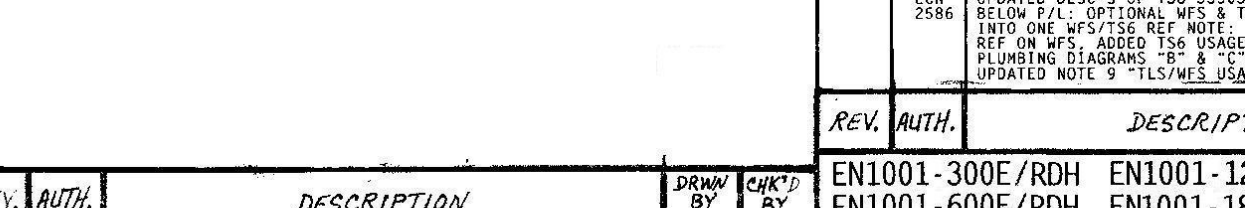
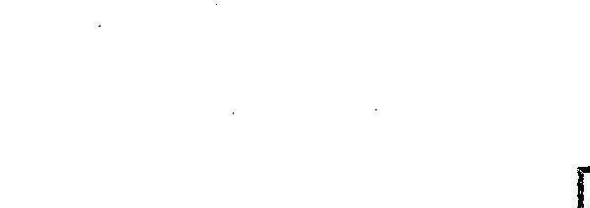
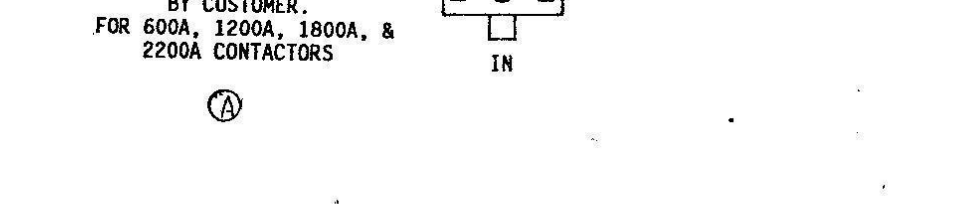
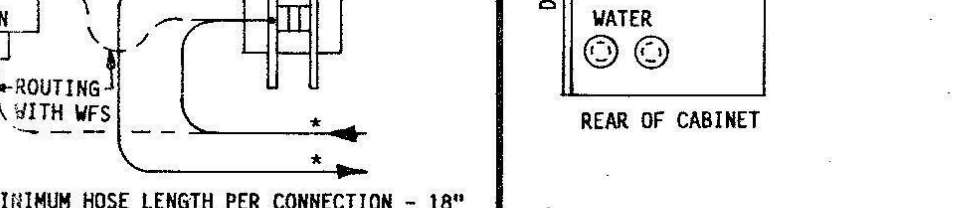
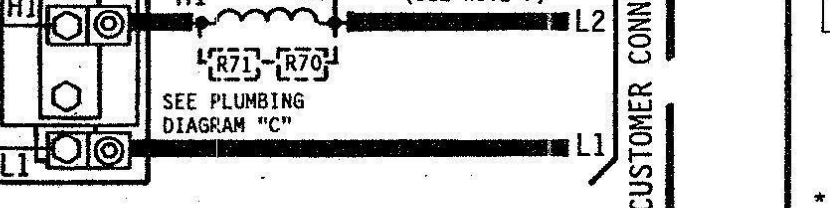
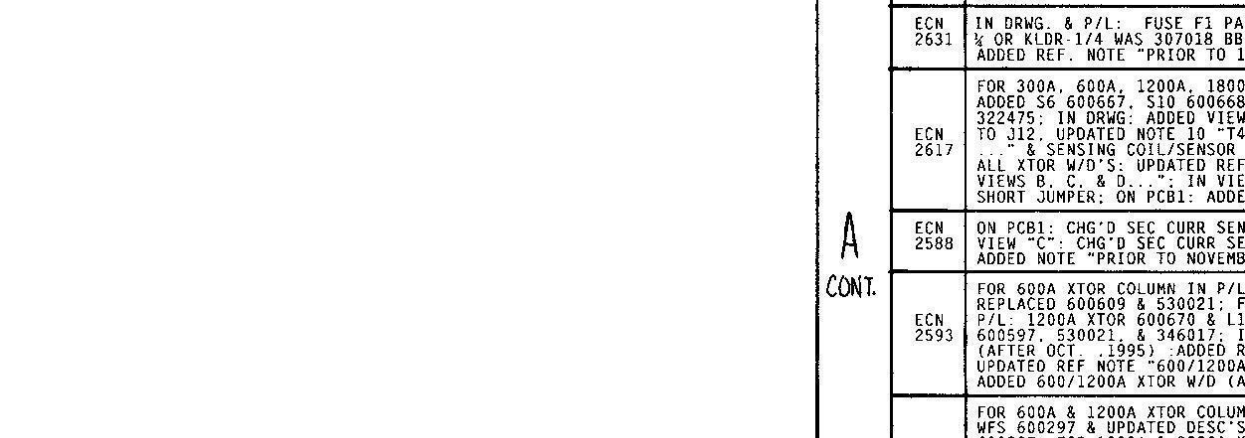
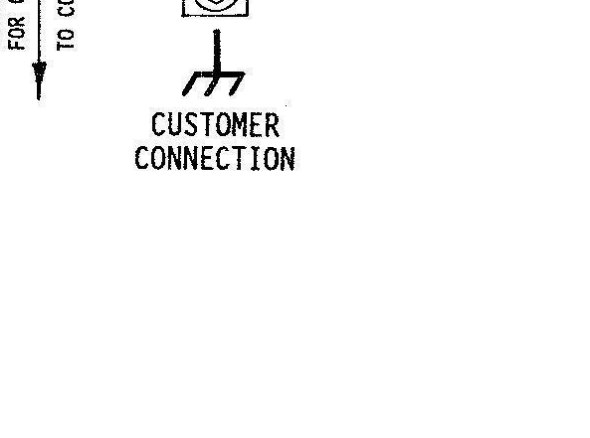
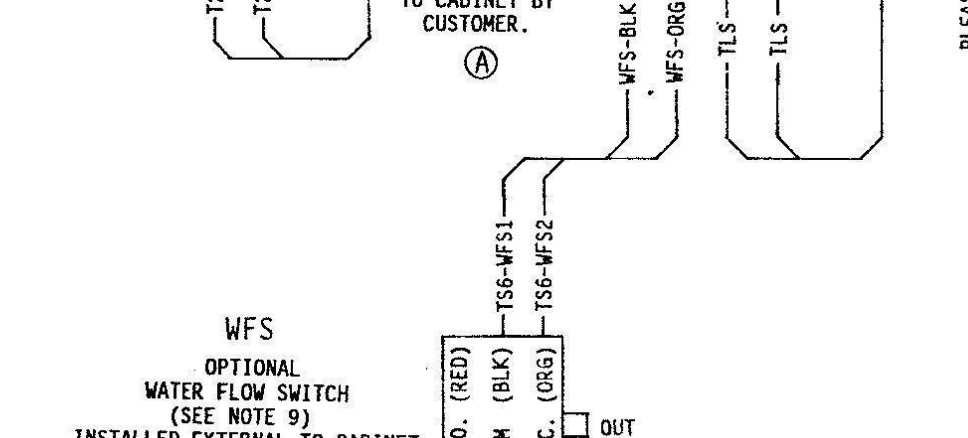
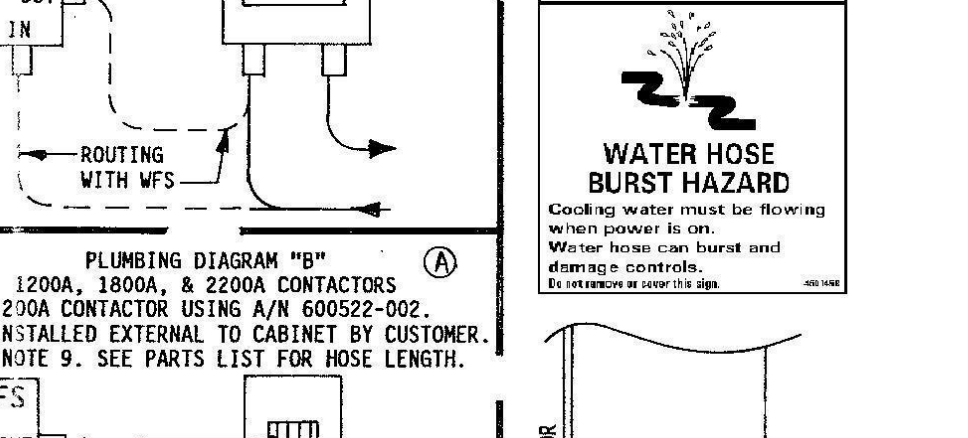
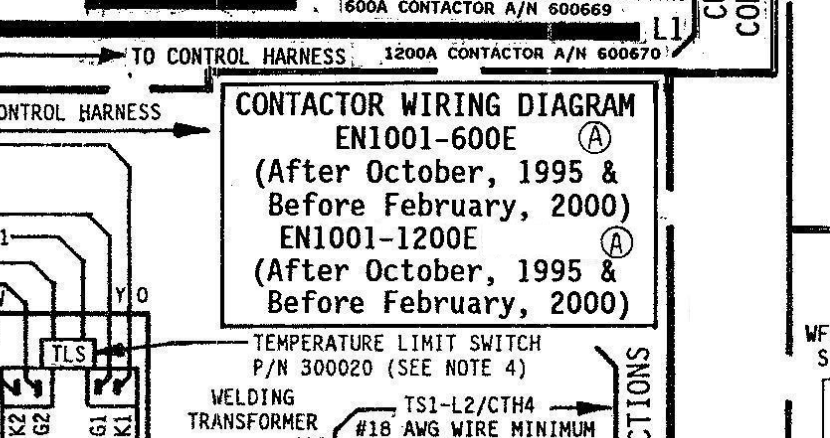
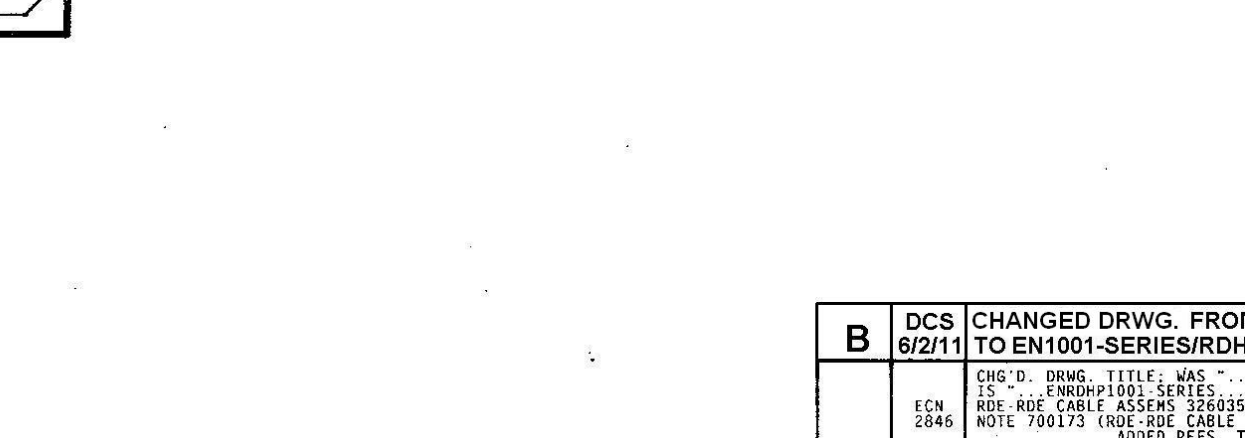
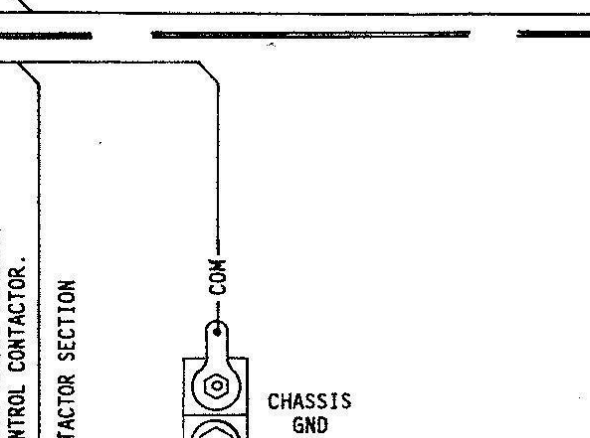
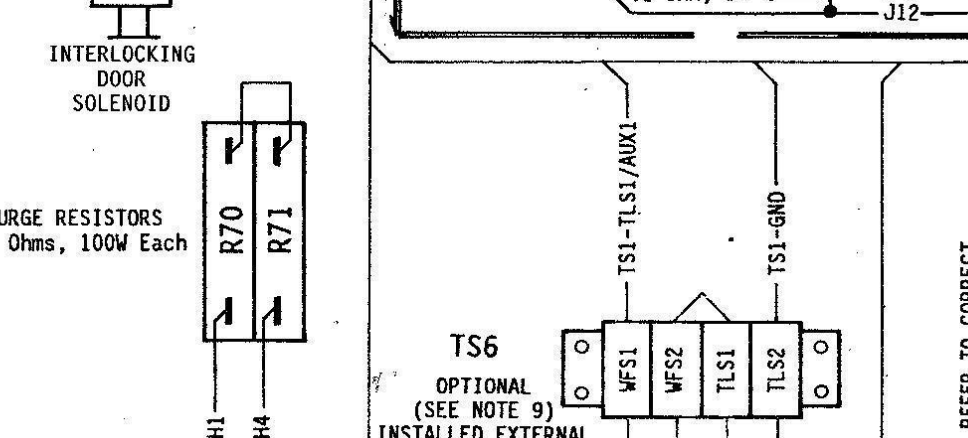
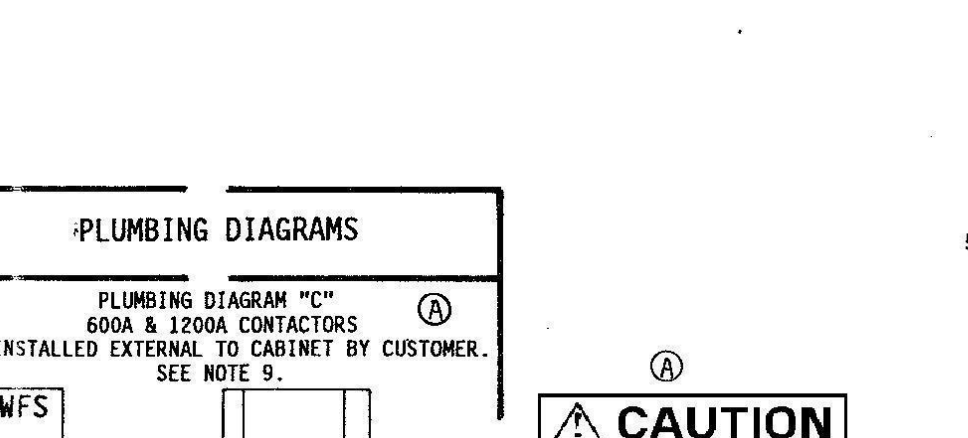
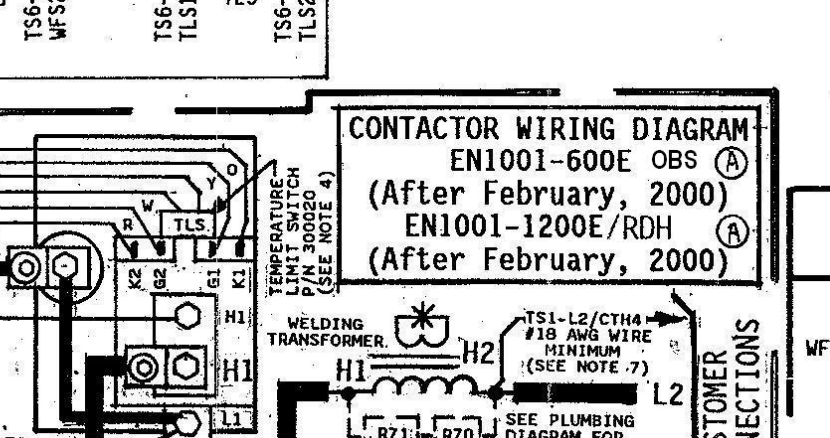
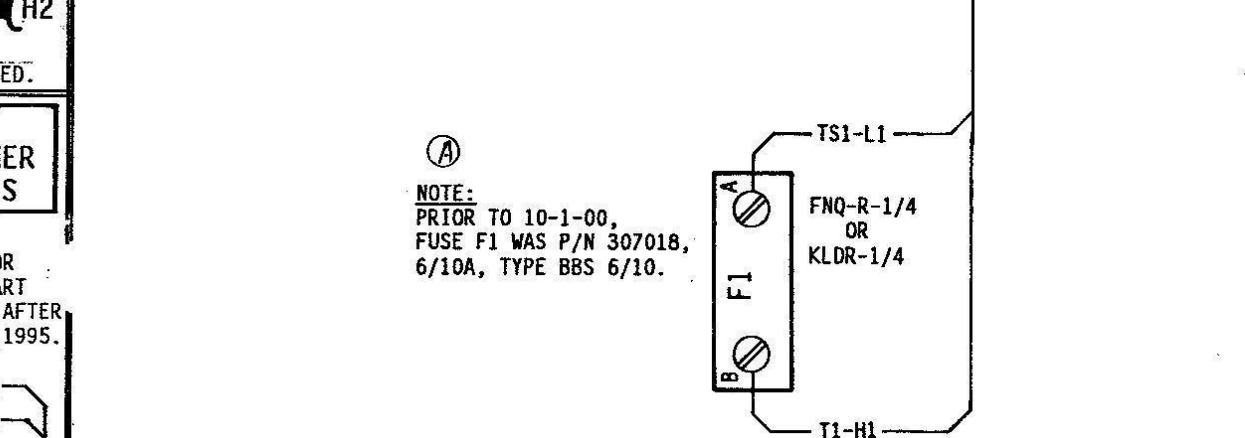
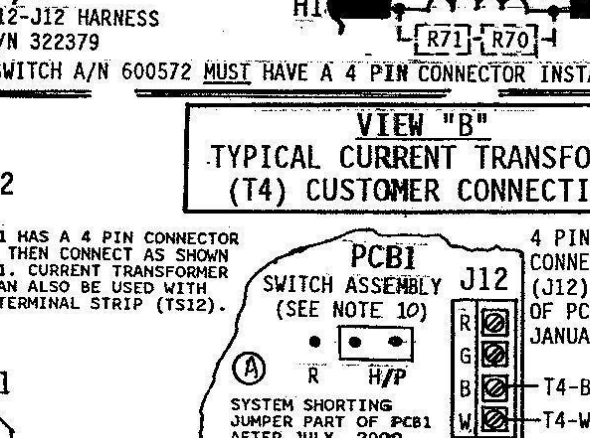
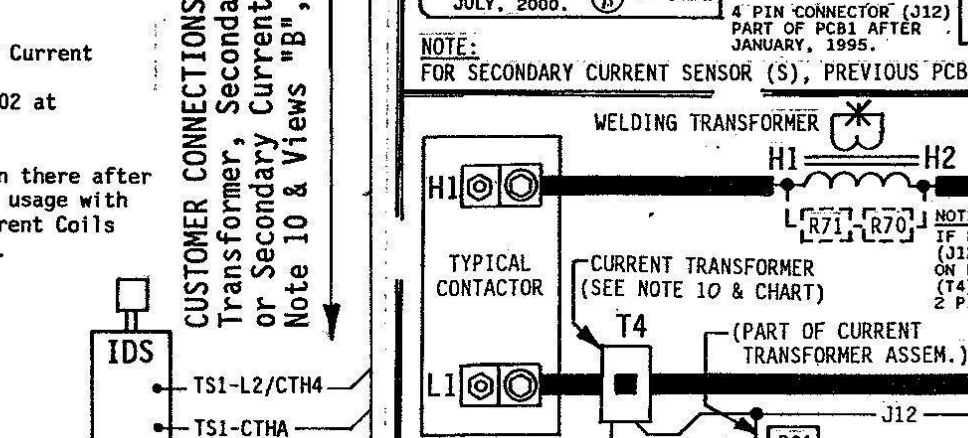
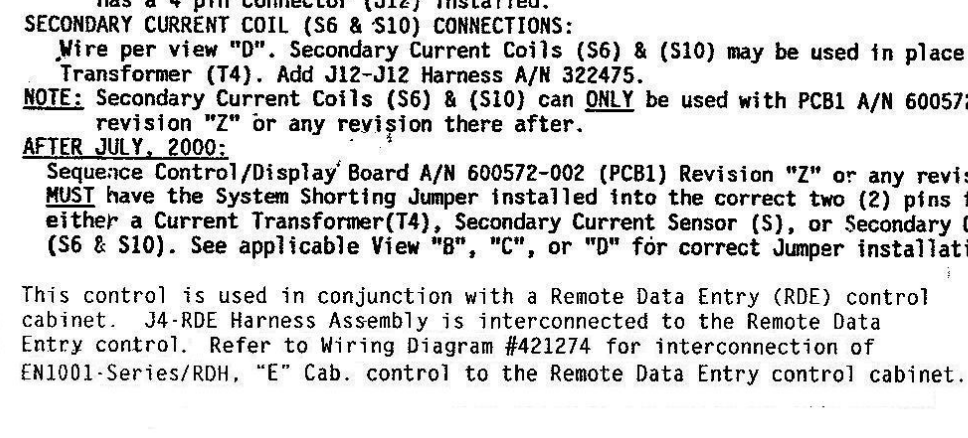
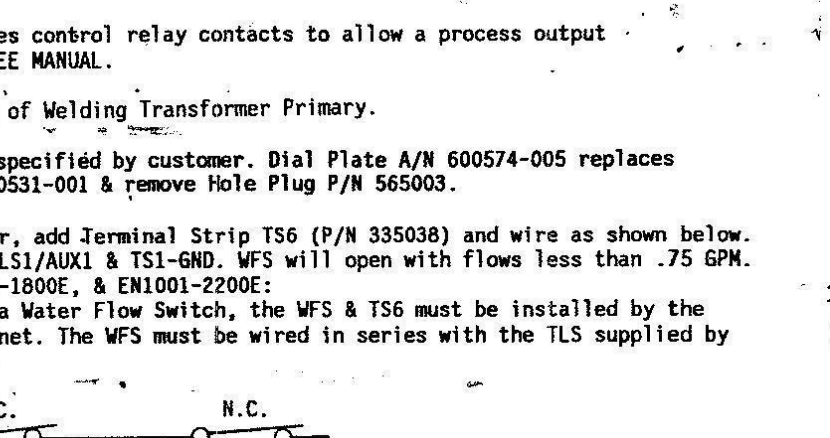
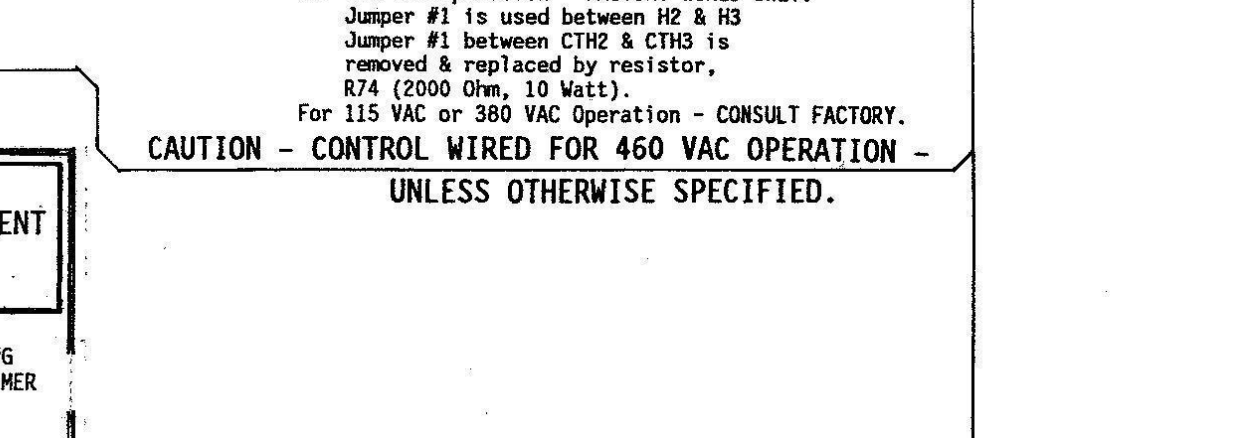
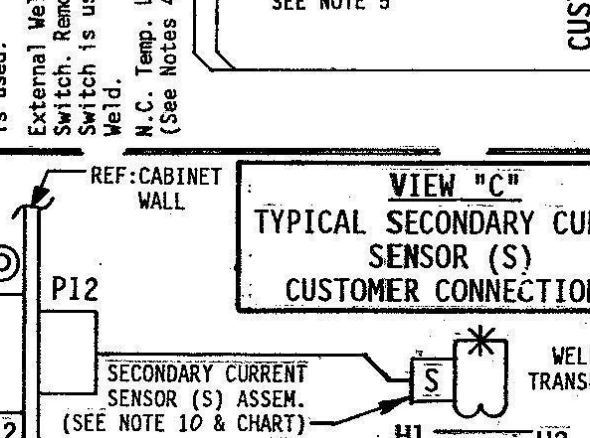
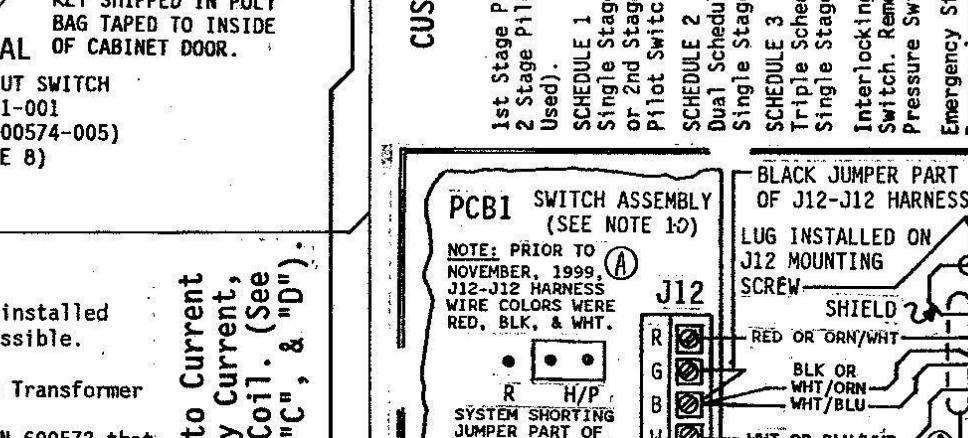
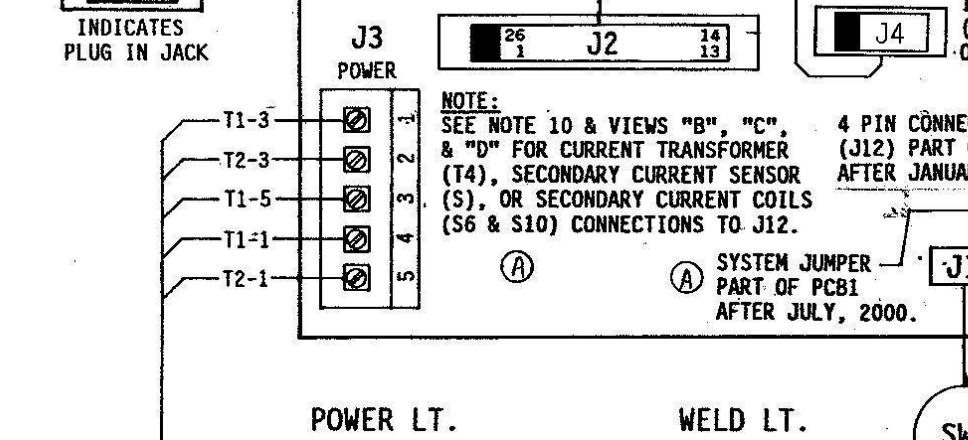
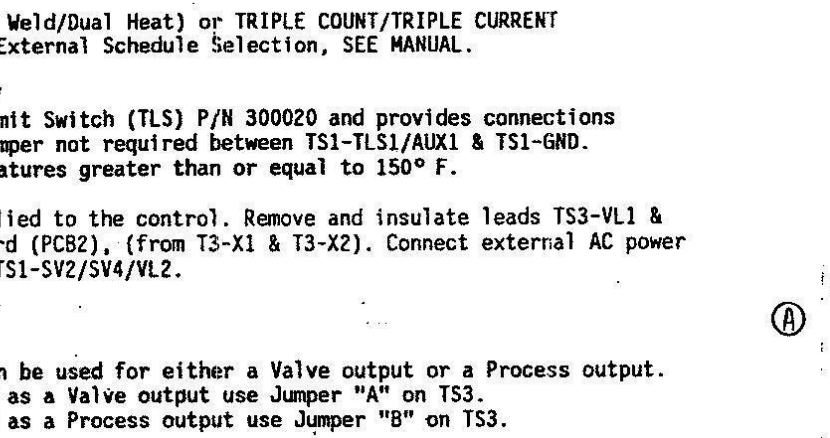
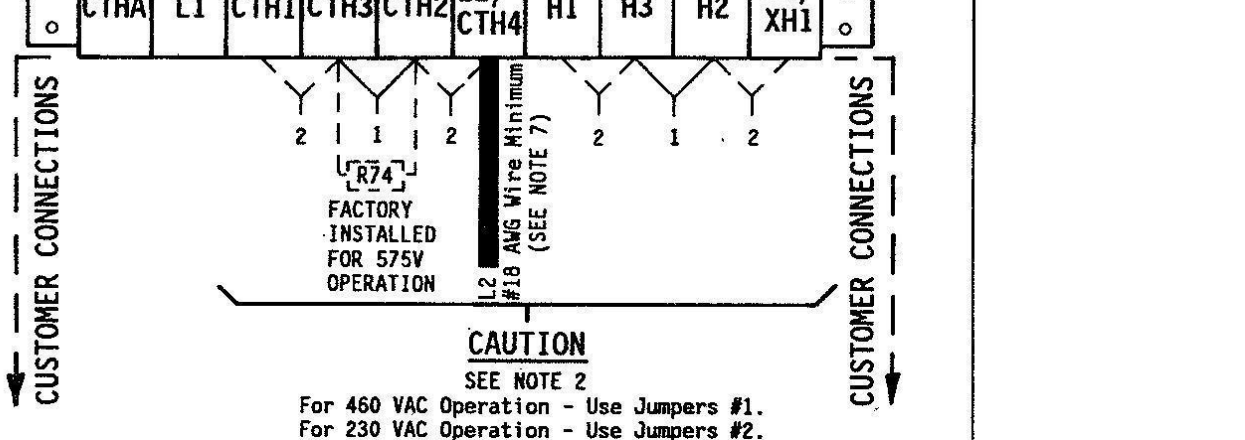
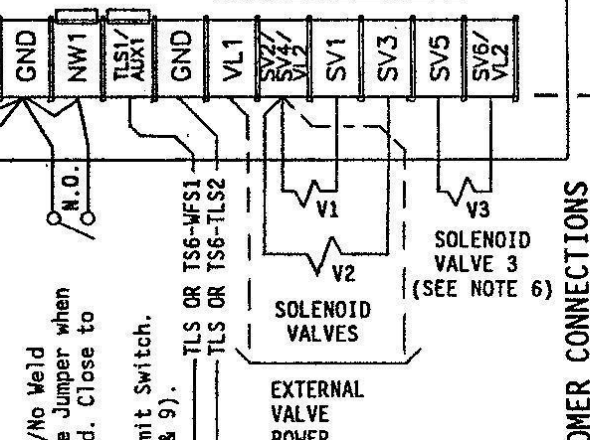
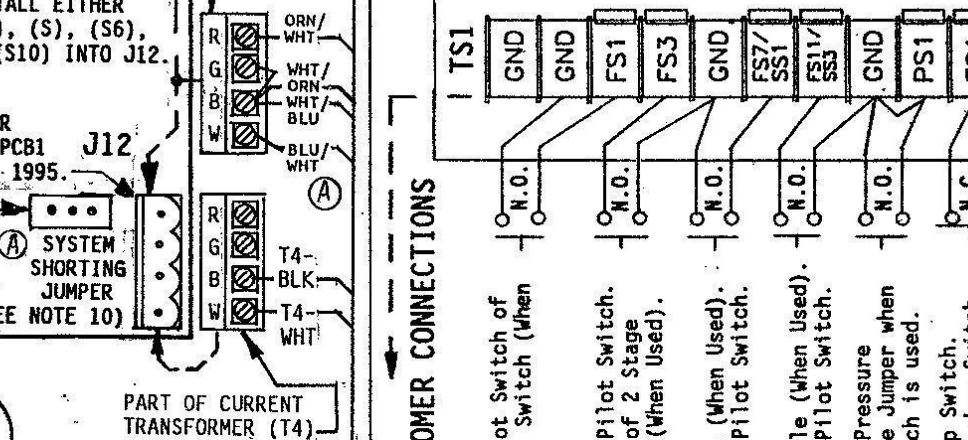
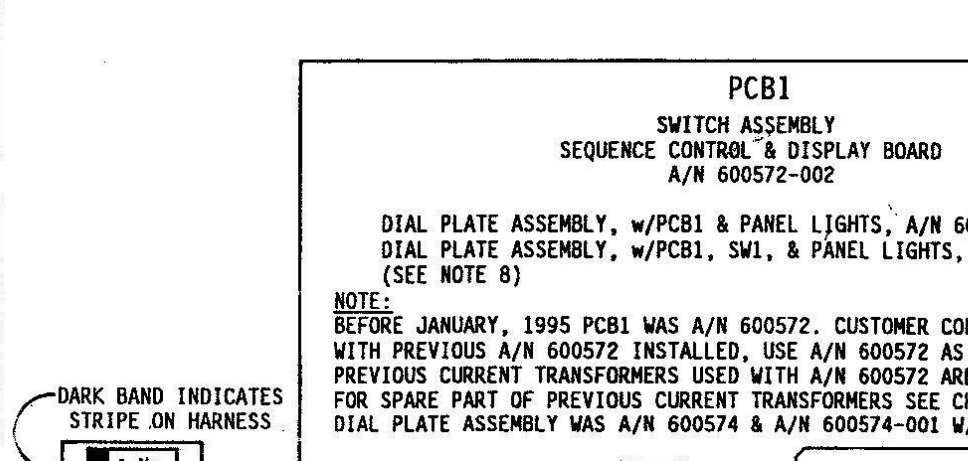
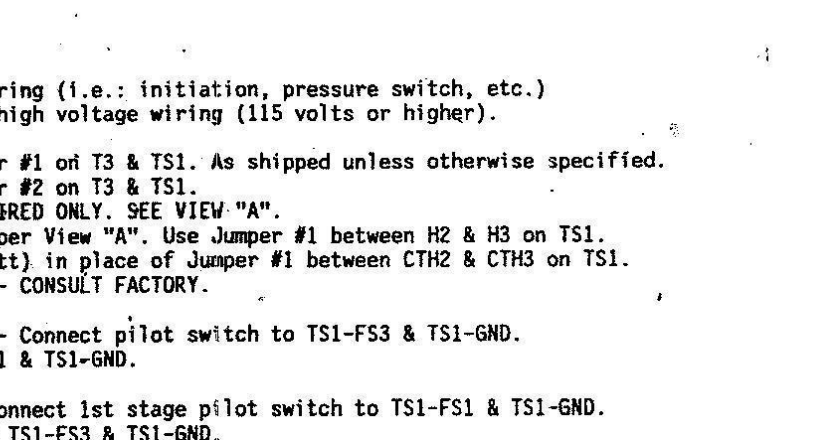
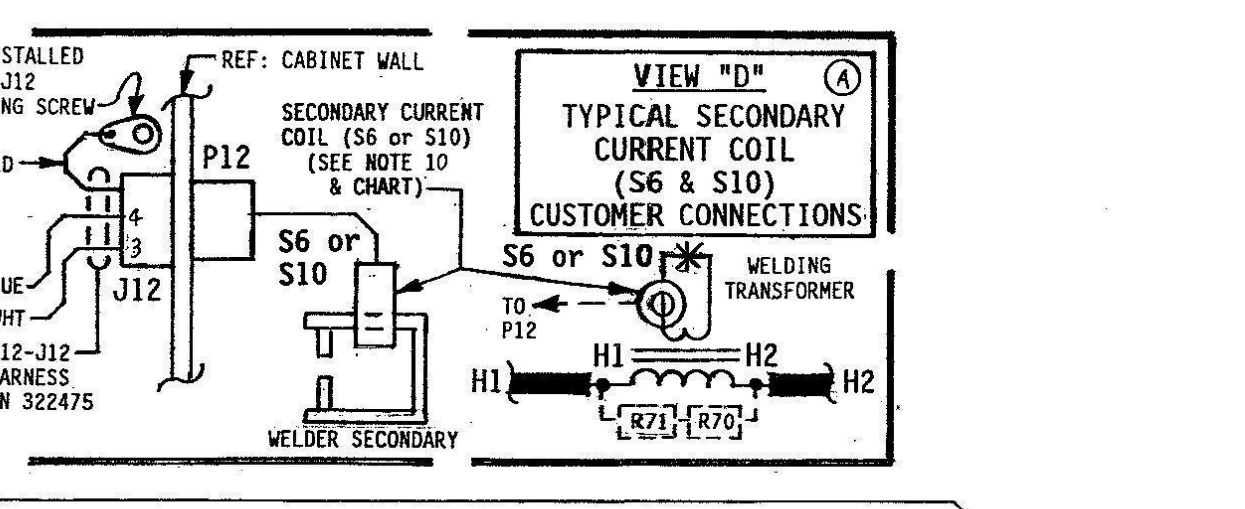
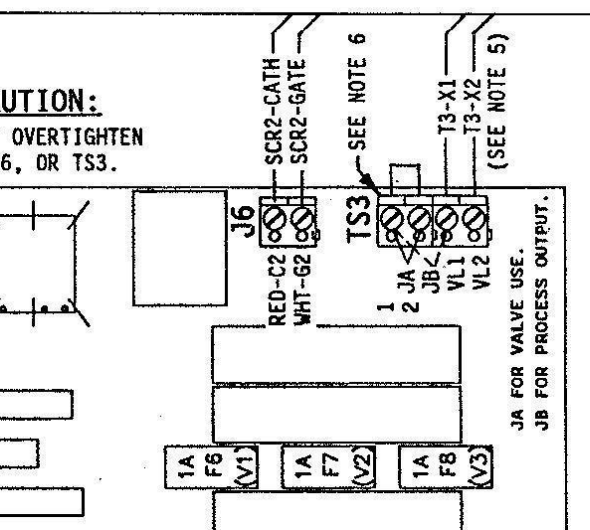
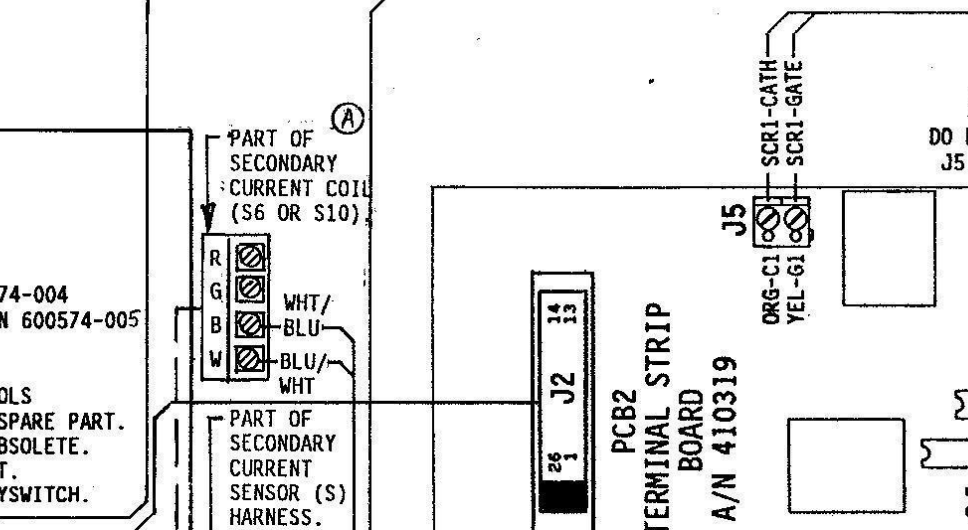

PARTS LIST - CONTROL SECTION. Table with columns: QTY., DESIG., PART NO., DESCRIPTION. Lists various components like Dial Plate, Switch, Keylock, etc.

PARTS LIST - CONTACTOR SECTION. Table with columns: QTY., DESIG., PART NO., DESCRIPTION. Lists various components like Terminal Strip, Resistor, Fuse, etc.

MANUFACTURING INSTRUCTIONS. Text providing details on packing, labeling, and assembly for the control section.

REVISION HISTORY. Table with columns: REV., AUTH., DESCRIPTION, DATE. Lists changes to the drawing over time.